



HITACHI
Inspire the Next

PSC-A64S CENTRAL STATION

INSTALLATION AND OPERATION MANUAL
MANUAL DE INSTALACIÓN Y FUNCIONAMIENTO
INSTALLATIONS- UND BETRIEBSHANDBUCH
MANUEL D'INSTALLATION ET DE
FUNCTIONNEMENT
MANUALE D'INSTALLAZIONE E D'USO

MANUAL DE INSTALAÇÃO E DE
FUNCIONAMENTO
BRUGER- OG MONTERINGSVEJLEDNING
INSTALLATIE- EN BEDIENINGSHANDLEIDING
HANDBOK FÖR INSTALLATION OCH ANVÄNDNING
ΕΓΧΕΙΡΙΔΙΟ ΕΓΚΑΤΑΣΤΑΣΗΣ ΚΑΙ ΛΕΙΤΟΥΡΓΙΑΣ



Do not perform installation work, without referring to our installation manual.
No realice la instalación de este equipo, sin antes consultar este manual de instalación.
Bei der Installation unbedingt die Hinweise in der Installationsanleitung beachten.
Consulter notre manuel avant de réaliser une quelconque installation.
Realizzare l'installazione, seguendo quanto indicato in questo manuale.
Nao inicie os trabalhos de montagem, sem consultar o nosso manual de montagem.
Udfor ikke installationsarbejder uden forst at donsultere vores vejledning.
Voer geen enkele handeling uit om de apparatuur alvorens deze hadleiding te hebben doorgelezen.
Utför inte nagra installationsarbeten utan att först läsa var installationsmanual
Μην ήσετε στην εγκατάσταση, χωρίς πριν να έχετε συμβουλευθεί αυτο το εγχειρίδιο εγκατάστασης

ENGLISH

ESPAÑOL

DEUTCH

FRANÇAIS

ITALIANO

PORTUGUES

DANSK

NEDERLANDS

SVENSKA

ΕΛΛΗΝΙΚΑ

1. SAFETY SUMMARY



DANGER:

DO NOT pour water into the central station. This product is equipped with electrical parts. If poured, it will cause a serious electrical shock.



WARNING:

DO NOT perform installation work and electrical wiring connection by yourself. Contact your distributor or dealer of HITACHI and ask them for installation work and electrical wiring by service person.

When performing the insulation test, withstand voltage test and so on, ensure to remove the FG terminal connection of TB1. If performing aforementioned test with the FG terminal connected, the malfunction will occur.

DO NOT turn OFF the power supply within 3 minutes after operation by the controller. It may cause malfunction.



CAUTION:

- *DO NOT install the indoor unit, outdoor unit, central station and cable at such places as;*
 - *where there is oil vapor and the oil is dispersed*
 - *where the hot springs are near (in a sulfuric environment)*
 - *where generation, flowing, staying or leaking of flammable gas is detected*
 - *where the sea is near (in the salty environment)*
 - *an acid or alkaline environment*
- *DO NOT install the indoor unit, outdoor unit, central station and cable within approximately 3 meters from strong electromagnetic wave radiators such as medical equipment. In case that the central station is installed in a place where there is electromagnetic wave radiation, shield the controller and cables by covering with the steel box and running the cable through the metal conduit tube.*
- *In case that there is electric noise at the power source for the indoor unit, provide a noise filter.*

2. INSTALLATION WORK



CAUTION:



Follow the national regulations for the right assembly of the PSC-A64S in the wall.

2.1. SELECTION OF INSTALLATION PLACE

- Select a suitable place for handling and determine the installation place of the controller with the customer's acceptance.
- Do not install the central station at such places as;
 - where children can touch
 - where the air from the air conditioner is directly discharged

2.2. BEFORE INSTALLATION

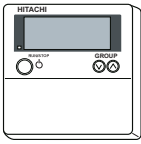
This packing contains the following parts:

	
Central Station	2 screws M4x16L For fixing the Holding Bracket onto the wall

2 INSTALLATION WORK

2.3. INSTALLATION SPACE

In case of installing the central stations in the vertical direction, keep a distance more than 50mm between the central stations vertically. If the distance is insufficient, the front cover of the central station can not open wide enough.

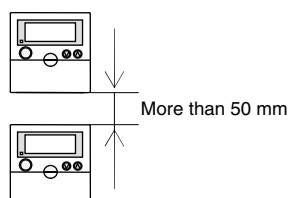

2.4. INSTALLATION PROCEDURES

1. Insert the edge of the screwdriver into the slot parts at the bottom of the case, push and turn the screwdriver and remove the control part from the power supply part. Do not insert the screwdriver into the nail near the slot part, or the nail will be damaged.

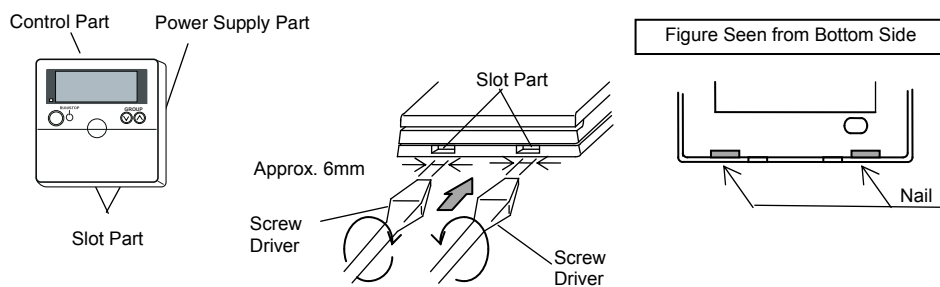

2. Attach the power supply part to the switch box.

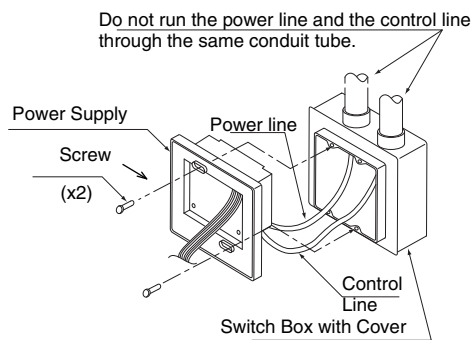

3. Attach the control part onto the power supply part. At first, attach the upper side, and then the lower side.

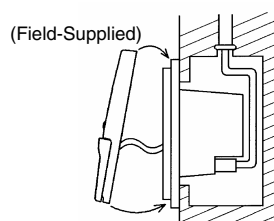

3. ELECTRICAL WIRING

3.1. ELECTRICAL WIRING

Up to 8 Central Stations can be connected to the H-LINK (Control line).

Use the 2-core cable of 0.75-1.25 mm² or the 2-core twist pair cable (Max. 1.000 m) for the transmission cable for the central station, for the outdoor unit and between indoor units (DC5V). The maximum total length of the cables shall be within 1.000 m.

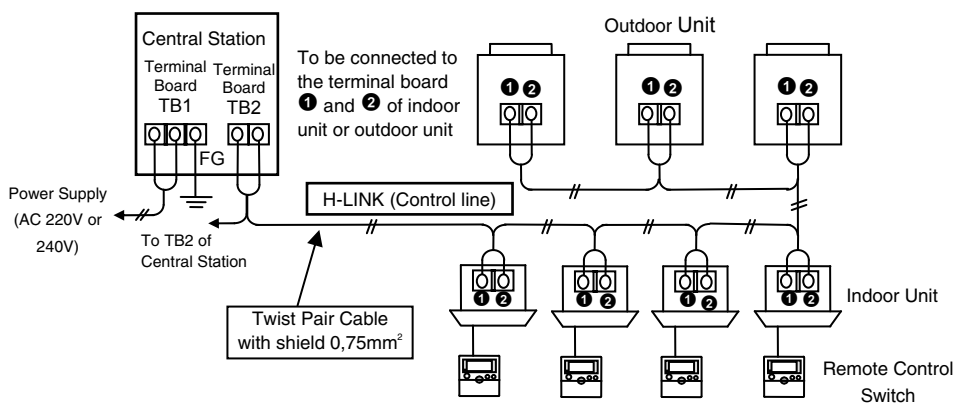

3.2. SETTING OF DIP SWITCH SET THE DSW1 AS SHOWN BELOW.

Address setting is required when the central station (Max. 8 units) is connected on H-LINK (Control line).

(The setting of dip switches is all OFF before shipping.)

	Pin N ^o	Contents	Setting of DSW		Remarks
			OFF	ON	
DSW1	1	For address setting	Refer to the description (as shown in page 4)		For connecting plural central stations with H-LINK (control line), the address setting for each central station is required
	2				
	3				
	4	Simultaneous use of other central controller	NO	YES	When using the following central controllers simultaneously, set the DSW1-4 pin ON -CS NET -CS NET-WEB
DSW2	1	External Input Function Changeover Operation Stoppage Level/Pulse	Level	Pulse	
	2	External Input Function Changeover Demand / Emergency Stop	Demand	Emergency Stoppage	-Available only when the DSW2-1 pin is OFF. -Pulse Stop when the DSW2-1 pin is ON.
	3	Not prepared	-	-	Set OFF
	4	H-LinkII Adaptive	Adaptive	Non-Adaptive	Set according to the item "Judgment of H-LINKII Adaptive" (shown in page 5)

4 ELECTRICAL WIRING

■ DSW1 (Address Setting)

Address 0	Address 1	Address 2	Address 3
Address 4	Address 5	Address 6	Address 7

i NOTE:

When using the central station PSC-5S and PSC-A64S together in the same H-LINK (control line) system, set the DSW1 not to be overlapped.

Divide the power line for the central station from the main power line by a pull box as shown in the figure.

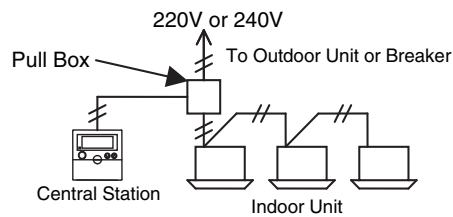

⚠ CAUTION:

- Check to ensure that the wiring is correct. Incorrect wiring may cause malfunction of the central station.
- Turn OFF the power supply of the air conditioner and the central station when performing the wiring work. If the wiring work is performed while the power supply of the central station is being supplied, it may cause malfunction of the central station.
- DO NOT run all the transmission cable for the central station along the power line and other transmission cables, or malfunction may occur due to the noise, etc. If the transmission cable for the central station is required to be run along the power line and other transmission cables, separate the cable more than 30 cm away from other cables, or run the cable through a metal tube and earth the tube.
- In case of applying high voltage to the TB2, the fuse on the PCB is blown out. In such a case, firstly correct the wiring to TB1, and then set N^o.2 pin ON.

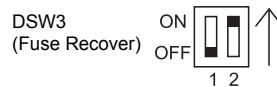

■ Judgment of H-LINKII Adaptive

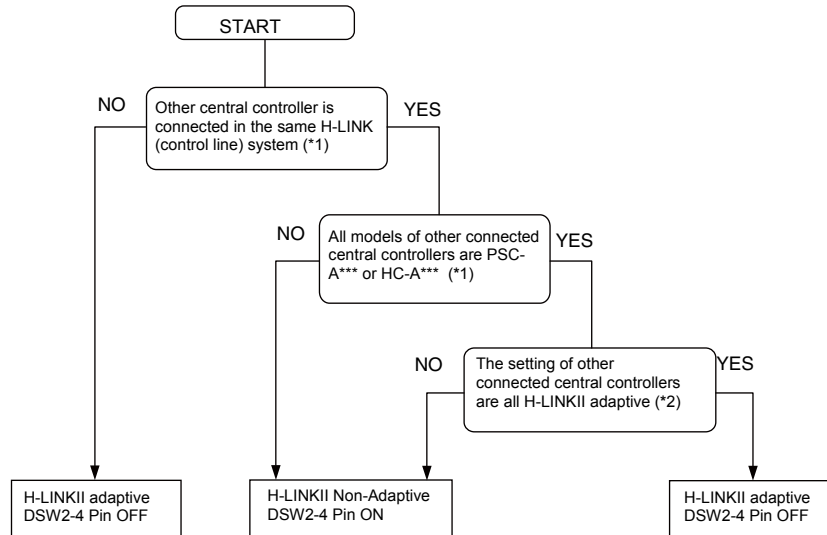

i NOTE:

(*1): The above "other central controllers" do not include PSC-5RA and PSC-5HR.

(*2): Refer to the installation manual of other central controllers for the setting contents.

4. GROUP SETTING

■ GROUP

Minimum unit for operation of Central Station.
One remote control switch group is considered as one group under the same control.
The Central Station can control up to 64 groups (4 zones x 16 groups).

■ ZONE

Operation unit with Plural Groups.
Up to 16 groups as maximum can be set in one zone. The central station can control up to 4 zones.

■ REMOTE CONTROL SWITCH GROUP

Unit of plural indoor units (max. 16 units).
Connected with Transmission Line of Remote Control Switch.
In this group the indoor units are under the same control setting.

6 GROUP SETTING

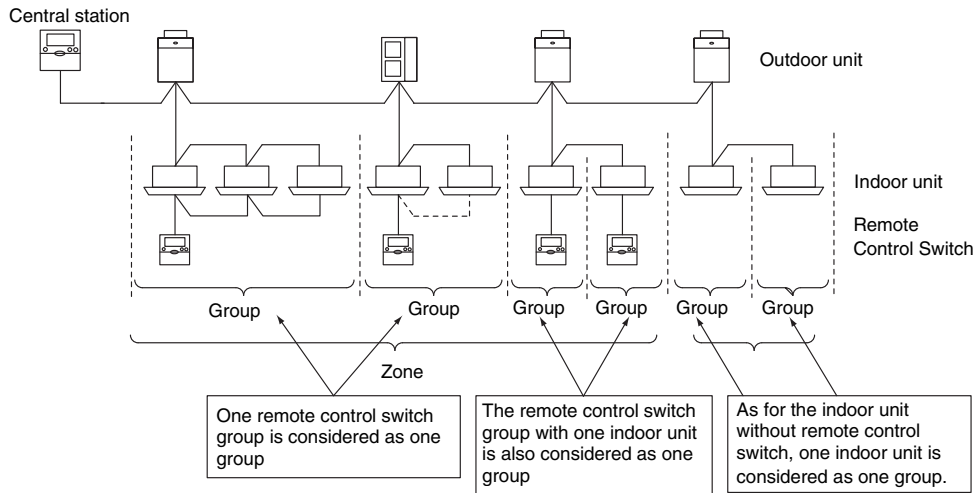

⚠ CAUTION:

When setting the remote control switch group without transmission line between indoor units, the indoor unit connected with the remote control switch shall be set as master unit. If the setting of the master unit is wrong, the group can not be controlled with the central station.

■ Check for connecting condition of air conditioner

After completion of electrical wiring work and test running of the air conditioner, turn ON the power supply of the central station. (Ensure to perform the test running of the air conditioner before turning ON the power supply of the central station).

In case that group setting is not performed, the indication of the central station is as shown below for checking indoor unit connection after turning ON the power supply.

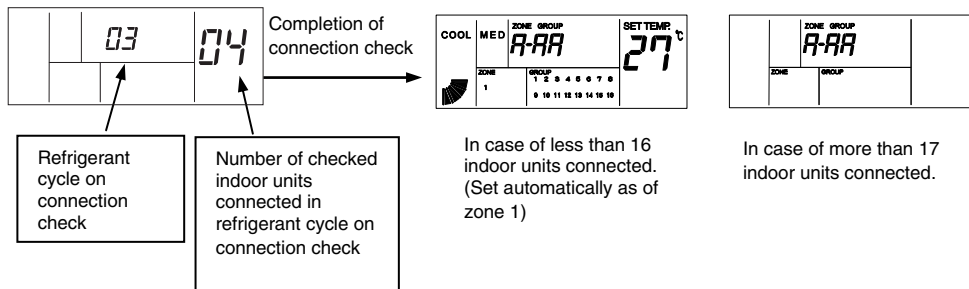

ⓘ NOTE:

The checked number of connected indoor units may be more than the actual number according to the condition of transmission.

After the connection check, the indications of "GROUP" and "SET TEMP." may be "-" temporarily.

When the "63" alarm is indicated, the setting of H-LINKII adaptive is wrong. Check for the setting of the central station and other central controller used together.

4.1. GROUP SETTING PROCEDURE

- The group setting consists of the master unit setting and the slave unit setting. The indoor unit, which is connected directly to the remote control switch, is set as the master unit, and the indoor unit connected with the transmission line is set as the slave unit.
- Without the remote control switch, the control by the remote control switch group is not available. Therefore, in this case, one indoor unit is set as one group. (Only the master unit is set without the slave unit).
- When setting the remote control switch group without transmission line between indoor units, the indoor unit connected with the remote control switch shall be set as master unit.
- When using the remote control switch (PC-AR(T)), the half-sized remote control switch (PC-ARH) or receiver kit (PC-ALH*), after the setting of master unit, the central station automatically set the slave unit.
- Check for the setting state by the slave unit setting mode.

4.1.1. SYSTEM OF LESS THAN 16 INDOOR UNITS CONNECTED, REFRIGERANT SYSTEM ADDRESS AND INDOOR UNIT ADDRESS.

The group is automatically set as zone N° 1 by the indoor unit address regardless of the refrigerant cycle address. Set the indoor unit address without duplication of address.

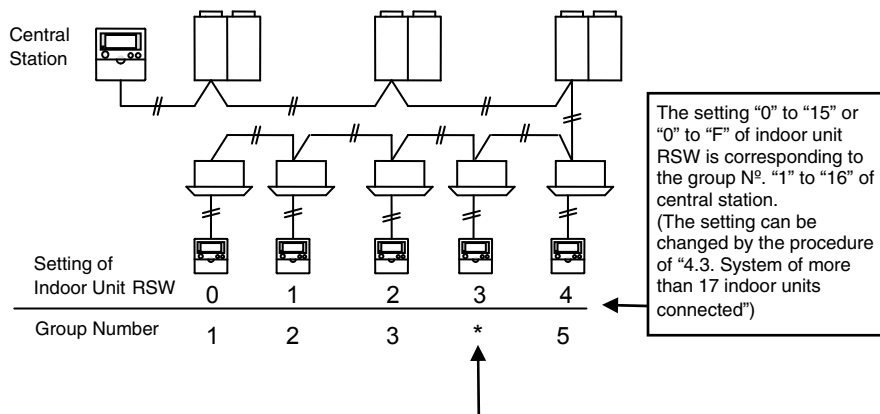

- When using the remote control switch (PC-AR(T)) or the half-sized remote control switch (PC-ARH) and the receiver kit (PC-ALH*), the indoor units are automatically recognized as the slave unit of the indoor unit 2 and set to the group 3. (The setting of the slave unit is not required. However, the contents of the setting should be checked.)
- When using other controllers than the described above, the indoor unit can not be recognized as the slave unit automatically, and set as the master unit of group 5. In this case change the setting to the slave unit of the group 3 according to the above "Group Setting Procedure".

8 GROUP SETTING

4.1.2. SYSTEM OF MORE THAN 17 INDOOR UNIT CONNECTED

In this case, the group setting by central station is required. Group setting is for master unit (directly connected to remote control switch) and slave unit (connected by extension cable). In case that the remote control switch is not connected, the group setting by remote control switch is not available and only one master unit is controlled as one group. In case of up to 16 indoor units connected, the group setting is automatically performed as described in "4.2. System of less than 16 indoor units connected, Refrigerant system address and indoor unit address". In this case, correct the group setting by the next procedure.

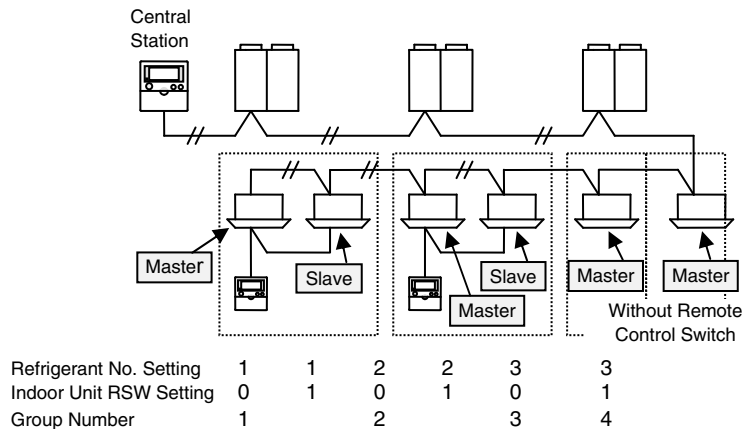

4.2. SETTING OF MASTER UNIT

4.2.1. INDICATION OF MASTER UNIT SETTING MODE

When the central station is changed to the master unit setting mode, the LCD indication on the central station is as shown below. The indication of the group to be set is flickered. The refrigerant cycle N° (hereafter called "Ref. N°") and the indoor unit address (hereafter called "I.U. Add.") indicates the address of the indoor unit which is set as the master unit of the group to be set. The "■" indication of group flickers in case that the master unit of the group is set. When the "SET" indication appears, the indoor unit indicated on LCD is set as the master unit. In case that the master unit is not set, "- -" is indicated at Ref. N° and I.U. Add., and the "SET" indication does not appear.

*When there is one or more group with indoor unit set as master unit in the zone, the zone indication "■" turns ON.

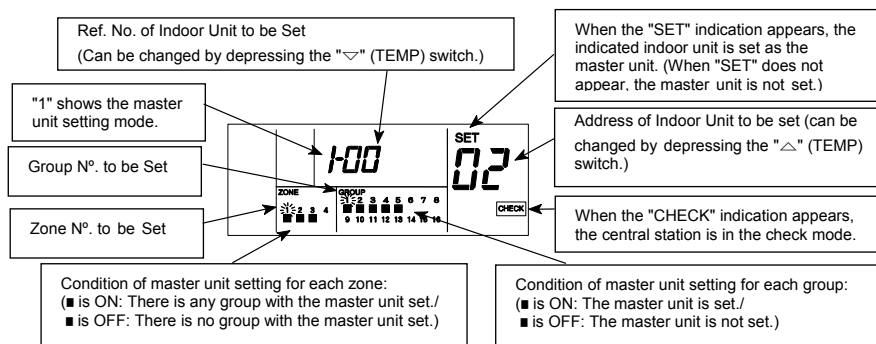

The above figure shows that the indoor unit of Ref. N°. "00" and I.U. Add. "02" is set as the master unit for Group 1 of Zone 1.

4.2.2. PROCEDURE OF MASTER UNIT SETTING

a. Screen change for Master Unit Setting keep depressing the "CHECK" switch for 3 seconds during all the indoor unit is stopped (with "RUN" indicator OFF). The "CHECK" indicator turns ON, and it shows the state is changed to the CHECK mode. In addition, "1" (master unit setting mode) is turns ON at the 7-segment indicator for checking.

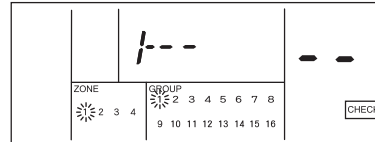

b. Select Zone to be set depress the "ZONE" switch, and the flickering indication of zone N° is changed in order as shown below.

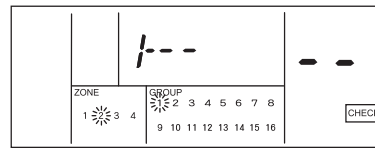
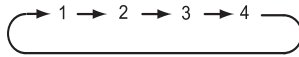

The above figure shows the case of selecting Zone "2".

c. Select of Group N°. to be set select the group to be set by depressing the "GROUP" switch. The flickering indication of group N° is moved in order as shown below every time the "GROUP" switch depressed.

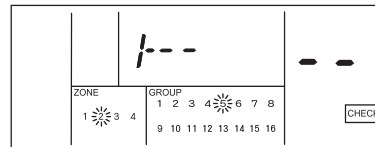
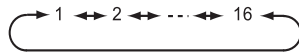

The above figure shows the case of selecting Zone "2" and group "5".

When the main unit of the selected group is already set, the Ref. N° and I.U. Add. of the main unit already set are indicated and the "SET" indication appears.

d. Selection of Indoor Unit to be set select the refrigerant system address and indoor unit address to set. The refrigerant system address is changed by depressing "▽" (TEMP) switch and the indoor unit address is changed by depressing "△" (TEMP) switch in order as shown below. In this case, the switch is kept depressing, and the indication of the refrigerant system address or the indoor unit address is fast-forwarded.

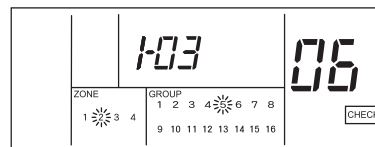
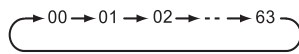

The above figure shows the case of selecting Ref. N°. "3" and I. U. Add. "6".

10 GROUP SETTING

● ATTENTION:

- When the indication of Ref. N° is "- -", the indication of I.U. Add. is also "- -". In such a case, I.U. Add. can not be changed although the "△" (TEMP) switch is depressed.
- Ref. N° with no indoor unit connected and I.U. Add. not connected are not indicated.
- The indoor unit already set as the master unit is not indicated.

e. Setting Procedure

Depress the "RUN/STOP" switch after selecting indoor unit, the indicated unit is set as the master unit, and the "■" and "SET" indications appear. The "■" indicator of zone turns ON when there is one or more group with the master unit set.

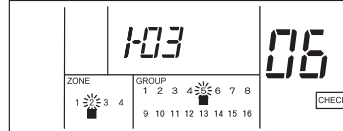

- f. Perform the master unit setting procedure b. to e. for each group and zone.
- g. After completion of the master unit setting, change the mode to the standard state by depressing "RESET" switch.

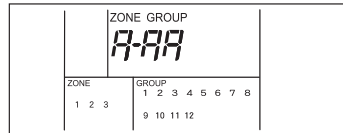

⚠ CAUTION:

- When there is any group in operation (with "RUN" indicator ON), the "CHECK" mode is not available.
- Only one indoor unit can be set as the master unit in one group. Other indoor unit can not be set as the master unit for the group with the master unit set already. For setting the master unit as the master unit for another group, cancel the present master unit setting and perform the setting for another group.
- In case that there are indoor units with auto-louver and indoor units without auto-louver in the same group, set the indoor unit with auto-louver as the master unit. If the indoor unit without auto-louver is set as the master unit, the auto-louver setting is not available for all the units of the group.
- When setting the remote control switch group without transmission line between indoor units, the indoor unit connected with the remote control switch shall be set as master unit.

4.2.3. CANCELLATION OF MASTER UNIT SETTING

- a. Screen change for cancellation of Master Unit setting keep depressing the "CHECK" switch for 3 seconds during all the indoor unit is stopped (with "RUN" indicator OFF). The "CHECK" indicator turns ON, and it shows the state is changed to the CHECK mode and "1" (master unit setting mode) turns ON at the 7-segment indicator for checking.

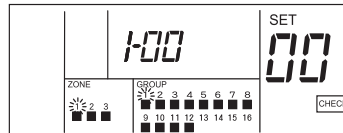

- b. Select of Zone to be canceled depress the "ZONE" switch and the "GROUP" ∨/∧ switch, and select the zone and the group to cancel.

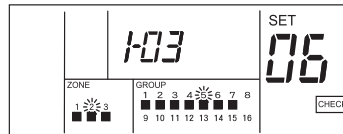

- c. Cancel the slave unit setting.

Depress the "RUN/STOP" switch and the master unit is canceled. The "SET" indicator and the "■" indicators of group turn OFF. The "■" indicators of zone turns OFF when there is one or more group with the master unit set.

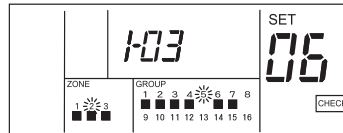

- d. Perform the cancellation of master unit setting procedure b and c for each zone and group.
- e. After completion of canceling the master unit setting, change the mode to the standard state by depressing "RESET" switch.

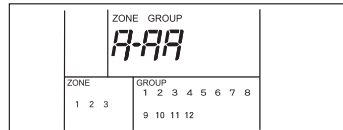

4.3. SETTING OF SLAVE UNIT

When using the remote control switch (PC-AR(T)), the half-size remote control switch (PC-ARH) or receiver kit (PC-ALH*), after the setting of master unit, the central station automatically set the slave unit.

Check for the setting state by the slave unit setting mode.

4.3.1. INDICATION OF SLAVE UNIT SETTING MODE

When the central station is changed to the slave unit setting mode, the LCD indication on the central station is as shown below. The indication of the group to be set is flickered. The Ref. N° and I.U. Add. indicates the address of the indoor unit with the smallest address among the slave units of the group to be set. The "■" indication of group flickers in case that the slave units of the group are already set. In case that the slave units are not set, "-.-" is indicated at Ref. N° and I.U. Add.

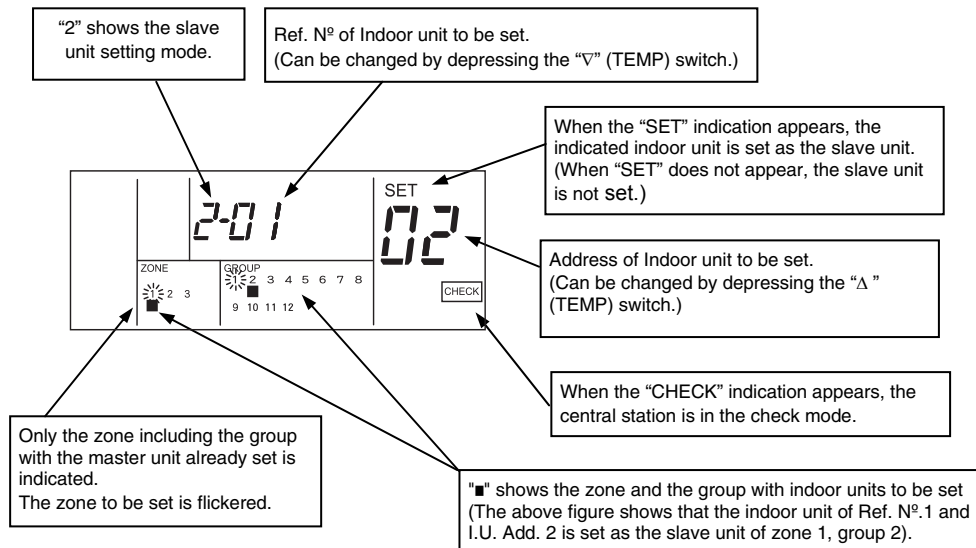

4.3.2. PROCEDURE OF SLAVE UNIT SETTING

- a. Screen Change for slave unit setting. Keep depressing the "CHECK" switch for 3 seconds during all the indoor unit is stopped (with "RUN" indicator OFF). The "CHECK" indicator turns ON, and it shows the state is changed to the "CHECK" mode. When "1" (master unit setting mode) is turns ON at the 7-segment indicator for checking, depress the "CHECK" switch again, and then the checking indication is changed to "2" (slave unit setting mode).

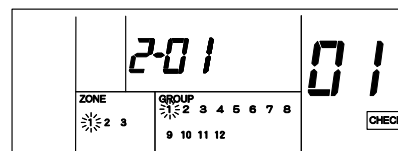

12 GROUP SETTING

- b. Select the refrigerant system address and indoor unit address to set. The refrigerant system address is changed by depressing "▽" (TEMP) switch and the indoor unit address is changed by depressing "Δ" (TEMP) switch in order as shown below. In this case, the switch is kept depressing, and the indication of the refrigerant system address or the indoor unit address is fast-forwarded.

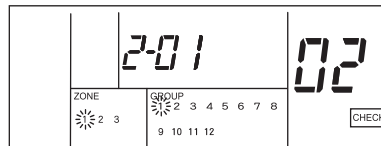
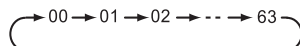

The above figure shows the case of selecting Ref. N^o. "1" and I. U. Add. "2".

● ATTENTION:

- Ref. N^o with no indoor unit connected and I.U. Add. not connected are not indicated.
- When the selected unit is already set as slave unit, the zone and the group N^o indication "■" of the unit and "SET" indication appear.
- The indoor unit already set as the master unit is not indicated.

- c. Select of Zone to be set.
Depress the "ZONE" switch, and the flickering indication of zone N^o is changed in order as shown below.

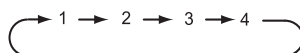

- * The zone, in which there is no group with the master unit already set, is not indicated.

- d. Select of Group to be set
Depress the "GROUP" switch, and the flickering indication of group N^o is changed in order as shown below.



- * The group, in which the master unit is not set, is not indicated.

- e. Setting Procedure
Depress the "RUN/STOP" switch after selecting zone and group, the slave unit is set.

The "SET" indicator and the "■" indicator of group turn ON.

- Perform the slave unit setting procedure "b" to "e" for each group and zone.
- After completion of the slave unit setting, change the mode to the standard state by depressing "RESET" switch.

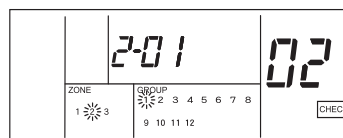

The above figure shows the case of selecting Zone "2".

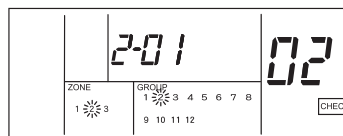

The above figure shows the case of selecting Zone "2" and group "2".

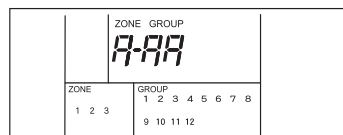
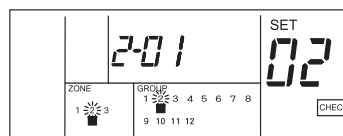

⚠ CAUTION:

- Up to 15 slave units can be set in one group (Max. 16 units (including the master unit) in one group).
- For changing the setting of slave unit to another group, cancel the present slave unit setting and perform the setting for another group.
- In case that all the units are set as the master unit, the central station can not be changed to the slave unit setting mode.
- When there is any group in operation (with "RUN" indicator ON), the "CHECK" mode is not available.

4.3.3. CANCELLATION OF SLAVE UNIT SETTING

a. Screen Change for Cancellation of Slave Unit Setting.
 Keep depressing the "CHECK" switch for 3 seconds during all the indoor unit is stopped (with "RUN" indicator OFF). The "CHECK" indicator turns ON, and it shows the state is changed to the CHECK mode. When "1" (master unit setting mode) is turns ON at the 7-segment indicator for checking, depress the "CHECK" switch again, and then the checking indication is changed to "2" (slave unit setting mode).

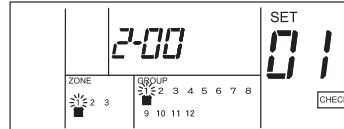

b. Select the refrigerant system address and indoor unit address to cancel. The refrigerant system address is changed by depressing "v" (TEMP) switch and the indoor unit address is changed by depressing "Δ" (TEMP) switch in order as shown below. In this case, the switch is kept depressing, and the indication of the refrigerant system address or the indoor unit address is fast-forwarded.

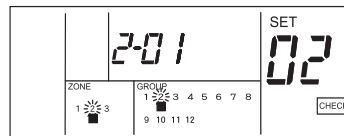

The above figure shows the case of selecting Ref. N^o. "1" and I. U. Add. "2".

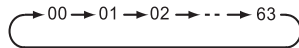

- * The Ref. N^o and I.U. address of the indoor unit unconnected are not indicated.
- * The Ref. N^o and I.U. address of the indoor unit set as the master unit are not indicated.

c. Cancellation of Slave Unit Address.
 Depress the "RUN/STOP" switch and the slave unit is canceled. The "SET" indicator and the "■" indicators of zone and group turn ON.

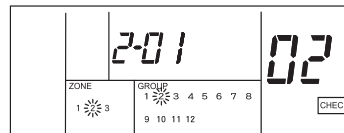

d. Perform the cancellation of slave unit setting procedure b and c for each intended refrigerant system and address.

e. After completion of canceling the slave unit setting, change the mode to the standard state by depressing "RESET" switch.

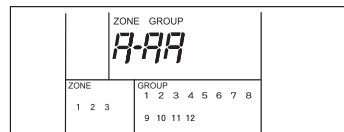

5. INPUT/OUTPUT FUNCTION

The central station has two input functions and two output functions as shown below.

1. Simultaneous Operation/Stoppage.
This function is for operating / stopping all the indoor units of the group, which is set by the central station, by the external contact signal.
2. Simultaneous Operation.
This function is for operating all the indoor units of the group, which is set by the central station, by the external pulse signal.
3. Simultaneous Stoppage.
This function is for stopping all the indoor units of the group, which is set by the central station, by the external pulse signal.
4. Emergency Stop signal connection function.
This function is for stopping all the air conditioners connected with the central station by the external emergency stop signal.
 - * When other central controller is used together with, even in the state of emergency stop, the RUN/STOP operation by other central controllers is available.
5. Demand Control Function.
The peak-cut according to the electricity is available by the control of air conditioners with the control signal from the demand control. The group set by the central station is operated by the demand signal as follows.

Table A. Input / Output Setting Mode and Connector

	Demand signal ON (1*)	Demand signal ON (2*)
Demand 1	Indoor Unit Stop (Remote Control Inhibited)	Back to the former state of operation
Demand 2 (*3,*4)	COOL, DRY→FAN HEAT→STOP (Remote Control Inhibited)	
Demand 3 (*3,*5)		The setting temperature is set as follows; COOL, DRY...28°C HEAT...20°C

*1: The control is performed every 15 seconds for the zone, which is subject to demand control, in descending order of the zone N^o

*2: The control is performed every 15 seconds for the zone, which is subject to demand control, in ascending order of the zone N^o

*3: During automatic cooling/heating operation, the activation of "Demand 1" is executed.

*4: For the group with the optional setting of fixing operation mode, the activation of "Demand 1" is executed.

*5: For the group with the optional setting of fixing operation mode or fixing set temperature, the activation of "Demand 1" is executed.

6. Simultaneous Operation Output.
This function is for outputting signal outward in the case where there is any air conditioner in operation in the group set by the central station.

7. Simultaneous Alarm Output.

This function is for outputting signal outward in the case where there is any air conditioner in abnormal condition in the group set by the central station.

The input function is set by DSW2 as shown in the table below:

Function	DSW Pin N°				Remarks
	1	2	3	4	
Simultaneous Operation/Stoppage (Level)	OFF	*	OFF	OFF	CN2 1-2 Pin Contact Connection
Simultaneous Operation/Stoppage (Pulse)	ON	OFF	OFF	OFF	CN2 1-2 Pin Contact Connection
Emergency Stop	OFF	ON	OFF	OFF	CN2 2-3 Pin Contact Connection
Demand 1~3	OFF	OFF	OFF	OFF	CN2 2-3 Pin Contact Connection

*Both ON and OFF setting are available. Set ON or OFF by the emergency stop or the demand function.

Specifications of Required Components:

- Input: DC12V, 10 mA Non-voltage A contact (pulse with more than 300 ms)
- Output: OMRON MY Relay
- Cable: PCC-1A

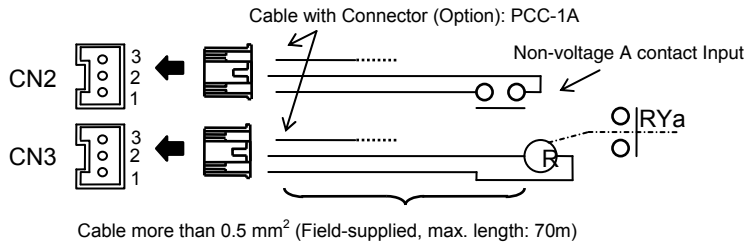

As for demand input, the group to be controlled can be set when signal is input.

5.1. DEMAND SETTING PROCEDURE

1. Changing to Check Mode.

Depress the "CHECK" switch for more than 3 seconds, and the central station is changed to the check mode.

* When there is any group in operation (with "RUN" indicator ON), the "CHECK" mode is not available.

16 INPUT/OUTPUT FUNCTION

2. Changing to Demand Setting Mode.

Depress the "CHECK" switch and change the 7-segment indication for check to "5" (Demand Setting Mode). The LCD indication of the central station is as shown below.

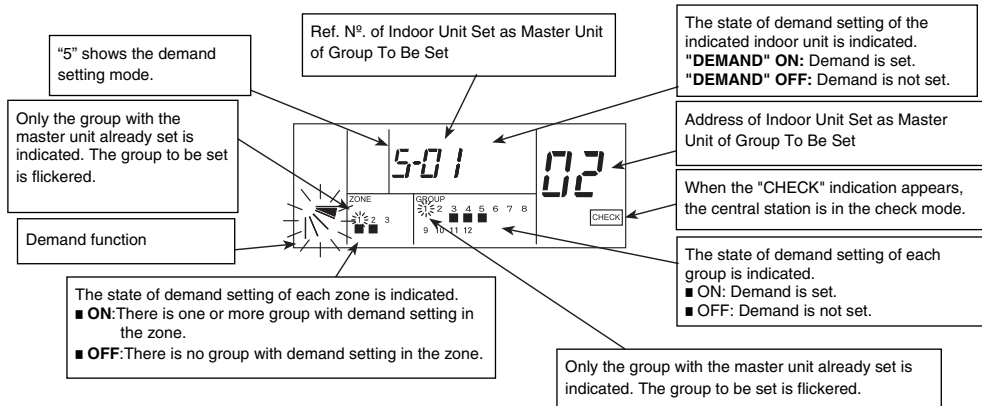

3 Selection of Demand Function.

- Select the demand function by depressing the "LOUVER" switch.
- Depress the "RUN/STOP" switch, and the flickering indication of louver angle turns ON.

By depressing the "LOUVER" switch, the indication of louver angle is changed as shown in right figure.

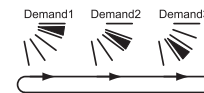

4 Selection of Group To Be Set

The demand function can be set for all the indoor units, each zone or each group. The "■" indication of "GROUP", for which the demand setting is already set, turns ON. In the case where there is one or more group with demand setting in the zone, the "■" indication of "ZONE" section turns ON.

- Simultaneous Setting for all Indoor Units
 - Depress the "ZONE" switch to make all the zone N°. flicker. Then, the minimum refrigerant system address and the minimum indoor unit address of the indoor unit, which is set as the master unit, in all groups are indicated.
- Setting for each Zone
 - Depress the "ZONE" switch and select the zone to set.
 - Depress the "GROUP" \vee/\wedge switch to make the group N° to set flicker. Then, the minimum Ref. N° and the minimum I.U. Add. of the indoor unit set as the master unit of all groups are indicated.

[Zone Selection]

Depress the "ZONE" switch, and the flickering indication of zone N° is changed in order as shown below.

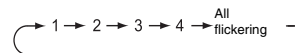

- * Only the zone N° to set is indicated.
- * When selecting the all flickering state (Simultaneous Operation for all Indoor Units), the groups to set are automatically fixed at the all flickering state. For selecting the group, select the indication state except all flickering.

- Setting for Each Group

- Depress the "ZONE" switch and select the zone to set.
- Depress the "GROUP" \vee/\wedge switch to select the group to set. Then, the Ref. N° and I.U. Add. of the indoor unit set as the master unit of selected group are indicated.

[Group Selection]

Depress the "GROUP" \vee/\wedge switch, and the flickering indication of group N° is changed in order as shown below.

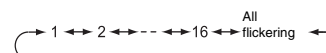

- * Only the group N° to set is indicated.

5. Setting Procedure

Depress the "RUN/STOP" switch and the selected group is set with demand control, and the "■" and "DEMAND" indications appear.

In the case where there is one or more group with demand setting in the zone, the "■" indication of zone turns ON.

(Every time the "RUN/STOP" switch is depressed, the demand control is set and canceled alternately.)

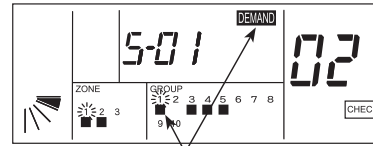

■ and "SET" Indications: ON
(The demand control is set.)

6. OPTION SETTING

6.1. CHANGING TO OPTION SETTING MODE

■ Changing to Option Setting Mode

1. Depress the "CHECK" switch for more than 3 seconds while all the groups are stopped. The central station is changed to the option setting mode and the "CHECK" indication appears, and "1" (Master Unit Setting Mode) is indicated on the 7-segment for check.

●ATTENTION:

When there is a group in operation, the central station can not be changed to the check mode.

2. Depress the "CHECK" switch and change the indication of the 7-segment.

7-Segment	Function
A	Fixing Operation Mode
b	Fixing Setting Temperature
c	Fixing Cooling Only
d	Fixing Air Flow
E	Auto COOL / HEAT

3. Depress the "RESET" switch and the central station is changed to the normal mode.

■ **Indication of Option Setting Mode**

When the central station is changed to the slave unit setting mode, the LCD indication on the central station is as shown below. The indication of the group to be set is flickered. The Ref. N° and I.U. Add. indicates the address of the indoor unit which is set as the master unit of the group to be set. The "■" indication of group flickers in case that the option setting is already done. When the "SET" indication appears, the indoor unit indicated on LCD is already set with the optional function.

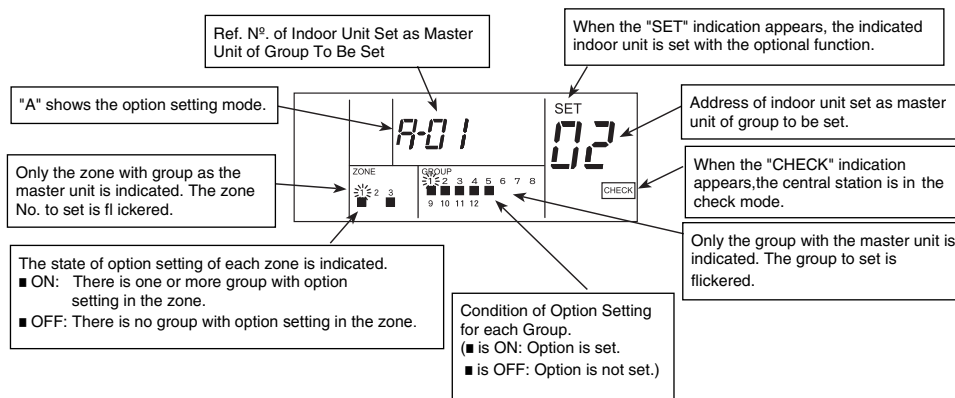

■ **Setting Procedure**

- Depress the "CHECK" switch and select the setting item A – E.
- Select the group to be set by depressing the "ZONE" switch and the "GROUP" switch. Refer to the "4.1. Group setting procedure" (page 7), for the group selection procedure.
- Depress the "RUN/STOP" switch, the selected group is subject to option setting and the "■" indication and the "SET" indication turn ON.

When there is one or more group with indoor unit set with option in the zone, the zone indication "■" turns ON.

Every time the "RUN/STOP" switch is depressed, the "■" indication and the "SET" indication turn ON and OFF alternately, and the state of option setting is changed; the selected group is to be set/not to be set with option setting.

⚠ **CAUTION:**

- In case that the optional functions are set by the central station, it is required to set the same optional functions for the group by the remote control switch.
- In case that the optional functions (items A – E as shown above) are set by the remote control switch, it is required to set the same optional functions for the group by the central station.
- The group, which is set with both of the fixing set temperature (option setting) and "Demand 3" function, is back to the former set temperature (before Demand ON) when the demand signal is OFF.

7. INITIALIZATION OF CENTRAL STATION

The procedure for initialization of the group setting and the optional setting is as follows.

7.1. CHANGING TO SELF CHECK MODE

Depress the "GROUP (∨^)" and "MODE" switches simultaneously, the central station is changed to the self check mode. In case that there is a group in operation, the "NO FUNCTION" is indicated and the central station can not be changed to the self check mode.

After changing to the self check mode, the LCD indication is changed as shown below. Then, depress the "GROUP(∨^)" and "MODE" switches simultaneously again, and the central station is changed to the initializing mode.

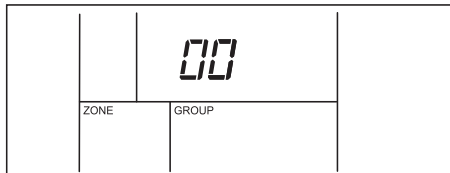

i NOTE:

In case that the "GROUP (∨^)" and "MODE" switches are not depressed again, the self check operation continues.

7.2. INITIALIZATION OF EEPROM

When the central station is changed to the initializing mode, the LCD indication on the central station is as shown below. In this condition, depress the "RESET" switch, and the flickering "06" indication is changed to ON and the initialization is performed.

(In case that initialization is not required, depress the "CHECK" switch, the LCD indication is automatically changed as shown below.)

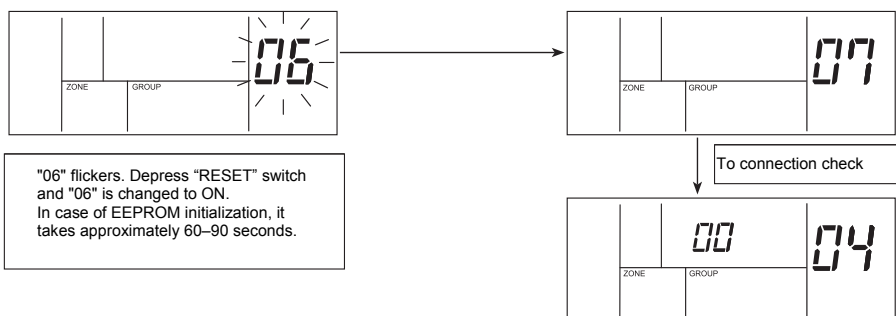

7.3. ZONE AND GROUP SETTING TABLE OF CENTRAL STATION (1)

Indoor Unit Address

	00	01	02	03	04	05	06	07	08	09	10	11	12	13	14	15				
00																				
01																				
02																				
03																				
04																				
05																				
06																				
07																				
08																				
09																				
10																				
11																				
12																				
13																				
14																				
15																				

Refrigerant number

Fill the group number (1-4) and the group number (1-16) in the above table.
Circle the unit number of the master unit.

8. SWITCH NAMES AND FUNCTIONS

■ Liquid Crystal Display Selection

The figure below shows all the indications for reference. The actual display during operation is different.

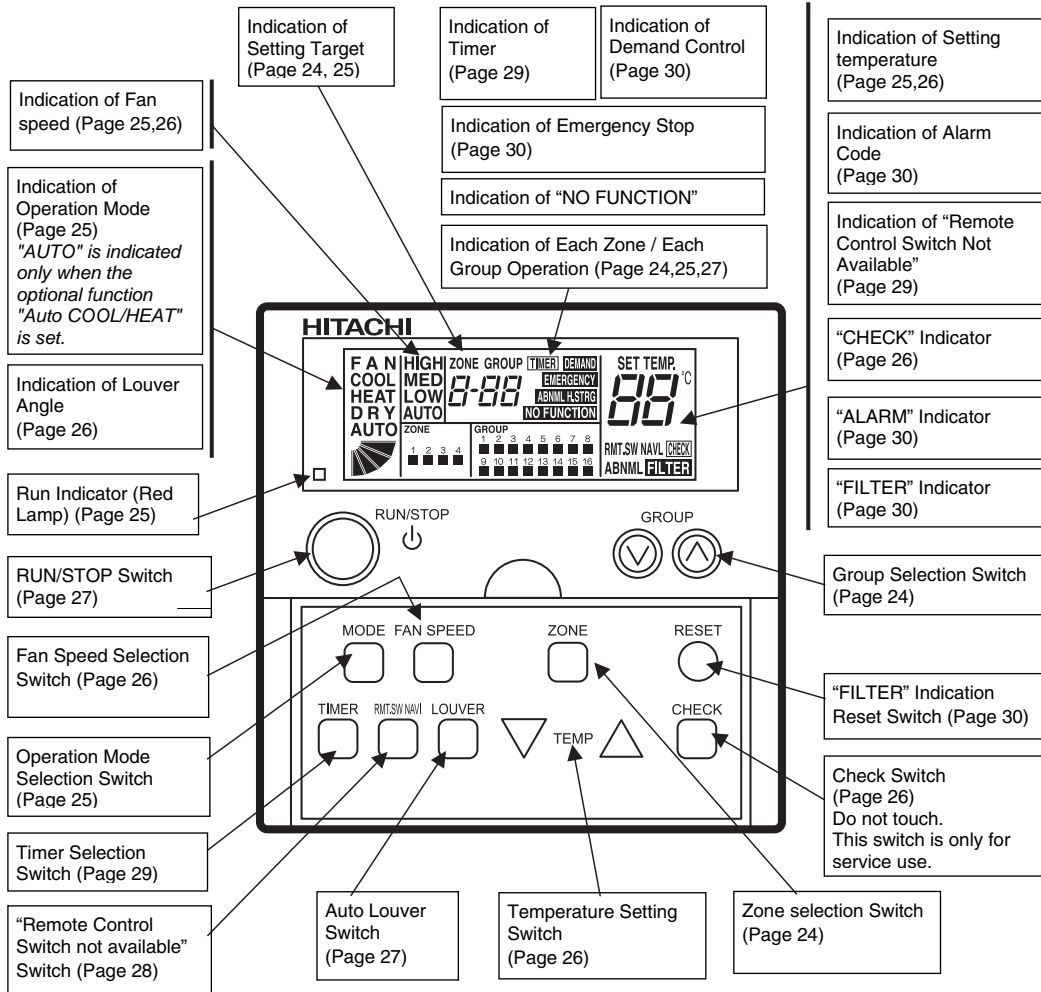

■ Operation Switch Section

The above figure shows the control timer with the cover opened.

When opening the cover, pull the cover toward the arrow direction.

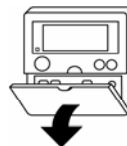

■ About Zone and Group

The central station controls plural indoor units as a unit (one indoor unit is also available). The operation unit is as follows;

Group	Minimum operation unit for central station One remote control switch group is considered as one group under the same control. The central station can control up to 64 groups (4 Zones x 16 Groups).
Zone	Operation Unit consisting of Plural Groups. Up to 16 groups can be set in one zone. The central station can control up to 4 zones.
Remote control switch group	Operation unit consisting of plural indoor units connected with transmission line of remote control switch. In the remote control switch group, the indoor units are under the same control setting.

■ Configuration of one and Group

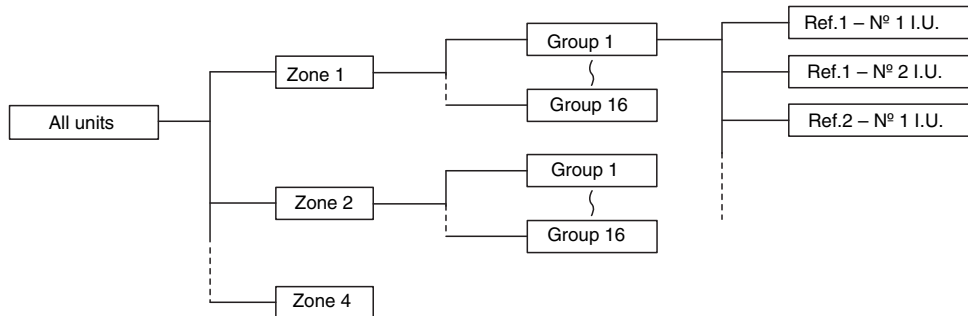

■ About Setting Target

The zone and the group subject to setting and monitoring are called as setting target. The central station indicates the setting target as shown below.

<p>Indication Example 1 This indication is the example in the case where the setting target is group. The setting of the selected group is ordered.</p>	<p>(ex. In case of Zone 1 and Group 2)</p>
<p>Indication Example 2 This indication is the example in the case where the setting target is zone. The setting of all the groups set in the selected zone is ordered.</p>	<p>(ex. In case of All Group in Zone 1)</p>
<p>Indication Example 3 This indication is the example in the case where the setting target is all the indoor units. The setting of all the units (all the groups) set is ordered.</p>	<p>(ex. In case of All Indoor Units)</p>



9. OPERATION PROCEDURE

9.1. SETTING TARGET SELECTION AND MONITORING OPERATION STATUS

The central station can control up to 64 groups by each group, each zone or simultaneously .
(The selected setting target can be operated and the unit operation status can be monitored.)

● **ATTENTION:**

When changing the zone N° by depressing the "ZONE" switch, the zone, which is not set as group, is not indicated.
The group number is changed by depressing the "GROUP" switch. The group without group setting is not indicated.

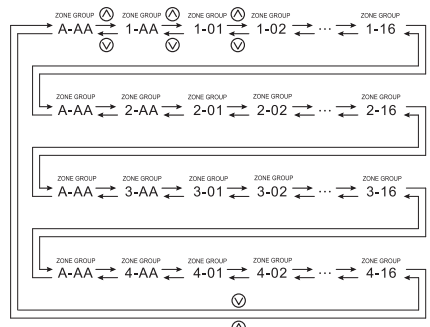
<p>Preparation 1 Supply power to the unit.</p> <p>● ATTENTION:</p> <p>A. Supply power to the unit more than 6 hours before unit operation for compressor protection. B. Do not cut off power during the term of using air conditioner.</p>	<p>The setting target zone and group N°. Is indicated on the liquid crystal display.</p> 
<p>Preparation 2 After the preparation for air conditioner operation is completed, turn ON the power supply of the central station.</p> <p>1. Depress the "ZONE" switch. Every time the "ZONE" switch is depressed, the zone and group N°. to be controlled is changed in the order as shown below:</p> <p style="text-align: center;">→ A-AA → 1-AA → 2-AA → 3-AA → 4-AA ←</p> <p>When the zone is changed, the setting target group is AA (All Groups) initially. For example, depressing "ZONE" switch when the setting target is 1-02, the indication is changed to 2-AA.</p>	<p>Zone N° is changed. (ex. In case of All group in Zone 3)</p>  <p>Only Zone N° Already Set are indicated.</p>
<p>2. Depress the "GROUP" switch. Every time the "GROUP" switch is depressed, the zone and group N°. to be controlled is changed in the order as shown below. In case of "AA", all the units are controlled simultaneously.</p> 	<p>Group N° is changed. (ex. In case of selecting Zone 3, group 5)</p> <p>Only Group N° already set are indicated.</p>

3. When selecting the group, the setting conditions of each group are indicated.
By operating by the remote control switch, the content of the setting is indicated.

Zone **1~4** show the operating conditions of each zone as follows;

- OFF ... Stoppage of All Groups in Zone
- ■ ON ... Operation of One or More Group in Zone
- ■ Flickering ... Failure in One or More Group in Zone

1 16 show the operating conditions of each group as follows;

- ■ Turned OFF: Stop
- ■ Turned ON: Operation
- Flickering: Abnormality

The Run indicator (Red Lamp) shows the followings;

- Turned OFF: All indoor units stop.
- Turned ON: More than 1 group in operation.
- Flickering: More than 1 group in abnormal condition.

Operating Conditions of Each Group (ex. In case of "COOL", "HIGH" and "28°C")

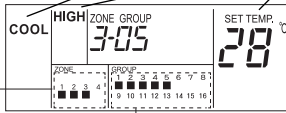

Operating conditions of each group (ex. In case of groups 1 ~ 5 of zone 3 in operation)

Operating Conditions of Each Zone (ex. In case of more than one group of each zone 1~3 in operation)

NOTES:

- The indication of setting temperature "- -" shows no setting of temperature.
- When the setting target group is "AA" (All Groups), the indications of operation mode, set temperature, fan speed, louver angle and remote control switch not available are indicated only for the items which all groups are under the same setting.
- When the setting target group is "A-AA" (All Indoor Units), the indication "■" turns ON when there is one or more group in operation in each zone, and also flickers when there is one or more group in failure in each zone.

9.2. SETTING OF OPERATION MODE

<Function>

- "COOL" Operation: To cool the room temperature by distributing the cooled air.
- "HEAT" Operation: To heat the room temperature by distributing the heated air.
- "DRY" Operation: To dehumidify more than standard cooling operation.
- "FAN" Operation: To circulate the room air.

NOTE:

The recommended temperature for each operation is as follows;
"COOL" Operation: 27~29°C / "HEAT" Operation: 18~20°C / "DRY" Operation: 23~25°C

1. Depress the "ZONE" switch and the "GROUP" switch and select the setting target.
(Refer to item "9.1. Setting target selection and monitoring operation status" in page 24)

COOL HIGH ZONE GROUP SET TEMP. °C

3-06 28

ZONE 1 2 3 4 GROUP 1 2 3 4 5 6 7 8

■ ■ ■ ■ ■ ■ ■ ■ ■ ■ ■ ■ ■ ■ ■ ■

The above figure shows the case of selecting "ZONE 3, GROUP 6".

2. Depress the "MODE" switch.
The operation mode is changed in the following order.

FAN → COOL → HEAT → DRY

HEAT HIGH ZONE GROUP SET TEMP. °C

3-06 28

ZONE 1 2 3 4 GROUP 1 2 3 4 5 6 7 8

■ ■ ■ ■ ■ ■ ■ ■ ■ ■ ■ ■ ■ ■ ■ ■

The above figure shows the case of setting "HEAT" operation.

NOTE:

- The above indications show the case of setting operation mode for "Zone 3, Group 6". The same setting procedure shall be performed for other groups.
- Some operation modes can not be set according to the unit model. Contact to HITACHI dealer or your distributor for details.
- The operation mode can be set while the unit is stopped or in operation.

9.3. SETTING OF TEMPERATURE, FAN SPEED AND LOUVER ANGLE

● ATTENTION:

- Do not touch the "CHECK" switch. The "CHECK" switch is only for service use.
- When the "CHECK" switch is depressed by a mistake and the central station is changed to the check mode, depress the "RESET" switch to cancel.

1. Depress the "ZONE" switch and the "GROUP" switch and select the setting target.
(Refer to item "9.1. Setting target selection and monitoring operation status" in page 24)

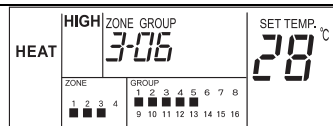

The above figure shows the case of selecting "ZONE 3, GROUP 6".

<TEMPERATURE>

Set temperature by depressing "TEMP" switch.

Depressing "∇" switch, the temperature is increased by 1 °C (Maximum: 30 °C).

Depressing "Δ" switch, the temperature is decreased by 1 °C (Minimum: 19 °C, for Cool, Dry and Fan mode, and 17 °C for Heat mode).

When depressing Δ for 3 seconds at set temperature at 30 °C, or depressing ∇ for 3 seconds at the minimum temperature, the temperature is not set and the indication of setting temperature is "-.". In this case, depress Δ or ∇, the indication of setting temperature returns to the minimum temperature or 30°C.

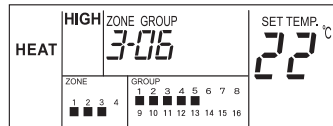

The above figure shows the case of setting 22°C.

NOTE:

The above shows the setting range for standard model. The setting temperature range may be different according to the connected unit model.

<FAN SPEED>

Depress the "FAN SPEED" switch.

By depressing the "FAN SPEED" switch, the indication is changed in the following order;

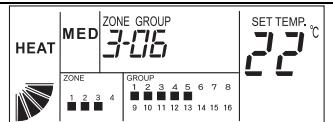
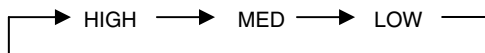

The above figure shows the case of setting "HIGH" fan speed.

NOTES:



- In case of dry operation, the fan speed is automatically changed and fixed at the "LOW" fan speed.
- In this case, the fan speed can not be changed (The indication remains at the setting condition).

<LOUVER ANGLE>

Depress the "AUTO LOUVER" switch.

Every time the "AUTO LOUVER" switch is depressed, the indication of the louver angle is changed.

Depress the "AUTO LOUVER" switch at the position

of , the indication is changed to  and this indication indicates the auto-swing. Depress the "AUTO LOUVER"

switch again, the indication is turned to 

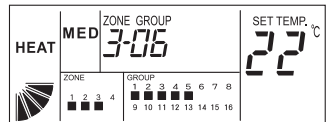

The above figure shows the case of setting auto-swing.

NOTES:

- The above indications show the case of setting operation mode for "ZONE 3, GROUP 6". The same setting procedure shall be performed for other groups.
- The temperature, fan speed and louver angle can be set while the unit is stopped or in operation.

In Case of 4-Way Cassette Type (Example)

LCD Indication							
Air Louver Angle	Approx. 25°	Approx. 30°	Approx. 35°	Approx. 40°	Approx. 50°	Approx. 55°	Approx. 60°
Cooling Dry		← Angle Range →					
Heat	← Angle Range →						

■ :Recommended Angle



NOTES:

- The fixing angle of the louver shown above is the case of 4-way cassette type indoor unit. The fixing angle is different according to unit model. Refer to the operation manual of each model for details.
- There exists a time lag between the indicated louver position on LCD and the actual louver angle in operation. Therefore, when fixing the louver, set the angle according to the indicated louver angle on LCD.
- When the "AUTO LOUVER" switch is depressed, the louver may not stop immediately.



ATTENTION:

The louver angle is automatically changed during heating operation for unit control.

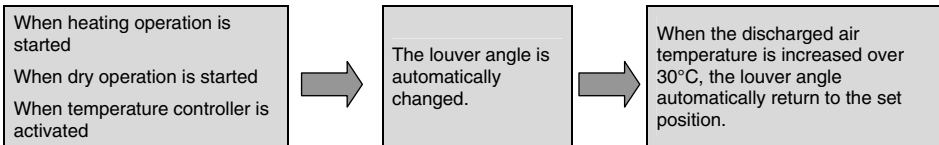

The LCD indication remains at the setting condition.

9.4. UNIT OPERATION

<p>1. Depress the "ZONE" switch and "GROUP" switch and select the setting target. (Refer to item 2 of "A. setting target selection and monitoring unit operation status" in page 18.)</p>	<p>The above figure shows the case of selecting "Zone 3, Group 6".</p>
<p>2. Depress the "RUN/STOP" switch. In case that the selected group is in operation, the group is stopped by depressing "RUN/STOP" switch. In case that the group is not in operation, the group is started by depressing the "RUN/STOP" switch. In case of group "AA", depress the "RUN/STOP" switch, and; - All indoor units are stopped (when more than 1 group is in operation (Run lamp is ON)). - All the groups are started operation (When all the groups are stopped (Run lamp is OFF)).</p>	<p>The above figure shows the case of "ZONE 3, GROUP 6".</p>



NOTES:

- The above indications show the case of setting operation mode for "Zone 3, Group 6"
- The same setting procedure shall be performed for other groups. In case of the simultaneous operation for all groups, select the group number of "AA".

■ Prohibiting Operation by Remote Control Switch

<Function>

To prohibit the operation by the remote control switch. When this function is available, the "CENTRAL" indication appears on the LCD on the remote control switch and the operation by the remote control switch is not available.

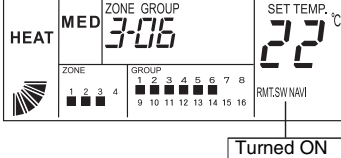
<p>1. Depress the "ZONE" switch and the "GROUP" switch and select the setting target. (Refer to item 2 of "A. Setting Target Selection and Monitoring Unit Operation Status" in page 18.)</p>	 <p>The above figure shows the case of selecting "ZONE 3, GROUP 6".</p>
<p>2. Depress the "RMT. SW NAVL" switch. Every time the "RMT. SW NAVL" switch is depressed, the "RMT. SW NAVL" indication is turned ON and OFF alternately.</p>	 <p>The above figure shows the case of "ZONE 3, GROUP 6" prohibited from operating by the remote control switch.</p>

● ATTENTION:

- The above indications show the case of setting operation mode for group 4. The same setting procedure shall be performed for other groups. In case of the same setting for all groups, select the group number of "AA".
- Although the "RMT. SW NAVL" function is set, in case of operation by the central station, the unit can be stopped by the remote control switch, and in this case, the unit can be started again by the remote control switch.
- For the unit without remote control switch, the "RMT. SW NAVL" function shall be set.
- In case of using together with other controllers, do not set the "RMT. SW NAVL" function. Additionally, do not set the "RMT. SW NAVL" function by other controller or the malfunction may occur.
- In case of no setting of temperature (" - "), the temperature can be set by the remote control switch during the "RMT. SW NAVL" function is available.

■ Timer Operation

<Function>

To set the schedule operation “available” or “not available” by the signal from the control timer in case of connection with the control timer (PSC-A1T; Option).
The schedule operation can be set “available” or “not available” individually for each unit, however, the operation schedule is all the same.

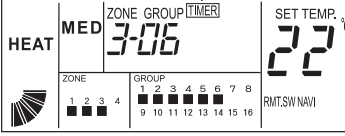
<p>1. Depress the “ZONE” switch and the “GROUP” switch and select the setting target. (Refer to item 2 of "A. Setting Target Selection and Monitoring Unit Operation Status" in page 18.)</p>	 <p>The above figure shows the case of selecting "ZONE 3, GROUP 6".</p>
<p>2. Depress the “TIMER” switch. Every time the “TIMER” switch is depressed, the “TIMER” indication is turned ON and OFF alternately. The group with timer setting is operated according to setting schedule by the signal from the control timer.</p>	<p style="text-align: center;">Turned ON</p>  <p>The above figure shows the case of "ZONE 3, GROUP 6" setting timer operation.</p>

NOTES:

The above indications show the case of setting operation mode for “ZONE 3, GROUP 6”
The same setting procedure shall be performed for other groups.

9.5. OTHER LCD INDICATIONS

■ Indication in Normal Conditions

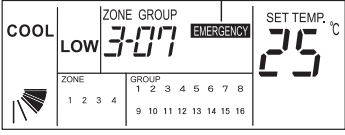
<p><EMERGENCY> The “EMERGENCY” is indicated when the emergency stop signal is input by the outside input function. During the emergency stoppage, indoor units are stopped and the operation by the remote control switch is not available. Contact your distributor or dealer of HITACHI for details.</p>	<p style="text-align: center;">Turned ON</p> 
---	---

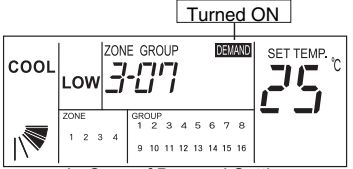
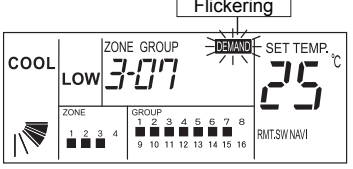
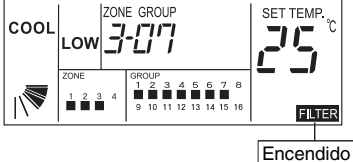
<p><DEMAND> The "DEMAND" is indicated when the demand input is set by the outside input function. The indication is indicated for the group with demand setting and the "DEMAND" indication flickers when the demand signal is input.</p> <p>Contact your distributor or dealer of HITACHI for details.</p>	 <p>In Case of Demand Setting</p>  <p>En el caso del ajuste de solicitud</p>
<p><FILTER> Filter Clogging: When the "FILTER" indication is indicated, it shows that the air filter of the indoor unit is clogged. Clean the air filter. After cleaning, depress the "RESET" switch and the "FILTER" indication is turned OFF.</p>	 <p>Encendido</p>

■ Indication in Abnormal Conditions

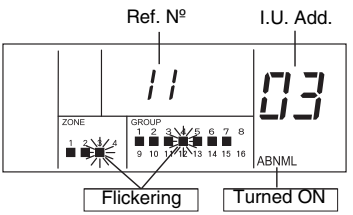
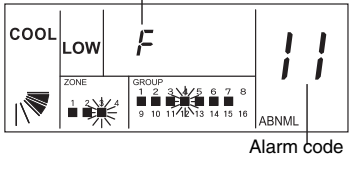
<p><ABNORMAL></p> <ol style="list-style-type: none"> The Run lamp (Red lamp) is flickered when there is a group in abnormal condition. The "ALARM" is indicated on the LCD. The "■" indication of the group in abnormal condition is flickered. Depress the "GROUP" switch and select the group with alarm, the indication of unit N^o, model code, alarm code, and the normal indication, is repeatedly indicated (there is a case that the model code may not be indicated according to the unit model). In case that multiple units are in abnormal conditions, the above indication is indicated by turns. <p>Check the contents of the LCD indication and contact your distributor or dealer of HITACHI for details.</p>	 <p>Model code</p>  <p>Alarm code</p>
<p><POWER FAILURE></p> <ol style="list-style-type: none"> All the indications are disappeared. In case of unit stoppage due to the power failure, the unit is not started again after the power recovery. Perform the starting operation again. In case of instant power failure within 2 seconds, the unit is automatically started again. 	
<p><ELECTRICAL NOISE> All the indications are disappeared, and the unit operation may be stopped for the device protection due to the electrical noise. Perform the starting operation again.</p>	